

DRY BATTERY

DRY | CONVENTIONAL

REF **12N24-4A**



12v VOLTAGE - v

220A CCA - A (EN)

25.2Ah CAPACITY - Ah (20Hr)

24Ah CAPACITY - Ah (10Hr)

TECHNOLOGY

- Lead acid dry charged construction (absorbed acid)
- No acid in cells, must be filled with acid before use
- 6 & 12V batteries

FEATURES

- Upright installation only
- Has to be checked periodically and refilled with water if necessary
- Internal gas emission through venting hole
- Handle with care to prevent acid spillage
- Regular life duration
- Does not need to be recharged while stocked

UPGRADE FOR

-

WEIGHT

Battery (with acid) : Approx 7.66kg

MOUNTING ANGLE

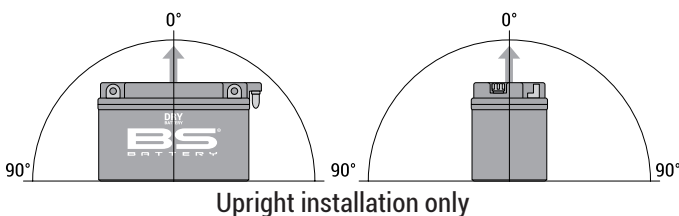

DIMENSIONS

Length (A) : 184±2mm
 Width (B) : 124±2mm
 Container height : 175±2mm
 Total height (C) : 175±2mm

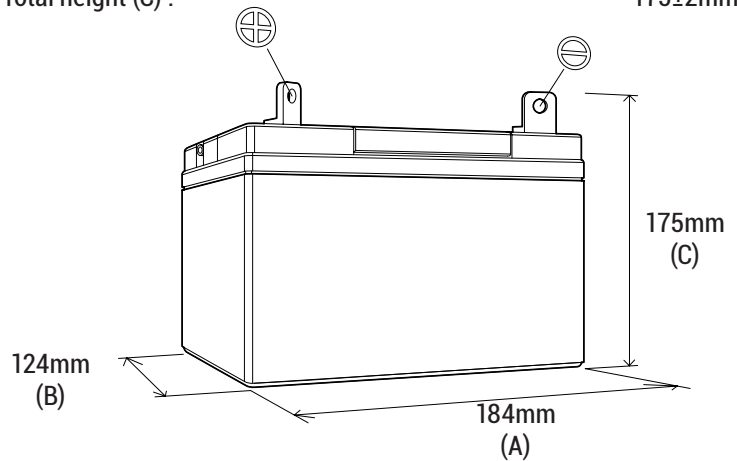

TERMINALS (mm)

