

# 12N7A-3A

BS CODE: **310800**

VOLTAGE **12V**

CCA **60A**

CAPACITY 20HR **7.4Ah**

CAPACITY 10HR **7.0Ah**







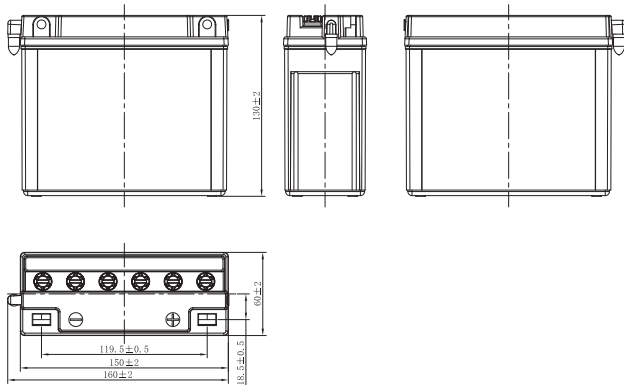

## DIMENSIONS

<b>LENGTH</b>	150 ±2mm	5.91 ±0.08inch
<b>WIDTH</b>	60 ±2mm	2.36 ±0.08inch
<b>TOTAL HEIGHT</b>	130 ±2mm	5.12 ±0.08inch
<b>WEIGHT</b>	1.82 kg ±5%	4.01 lbs ±5%



## DRY FEATURES

-  **TO BE ACTIVATED**  
DRY-charged technology.
-  **ACID PACK INCLUDED**  
For initial filling.
-  **PERIODIC MAINTENANCE**  
Refilled with water if necessary.
-  **HANDLE WITH CARE TO PREVENT ACID SPILLAGE**
-  **LONG SHELF LIFE**  
No need to be recharged while stocked (if not activated).
-  **INTERNAL GAS EMISSION THROUGH VENTING HOLE**
-  **WIDE VARIETY OF 6V & 12V MODELS**

## TERMINAL (mm)

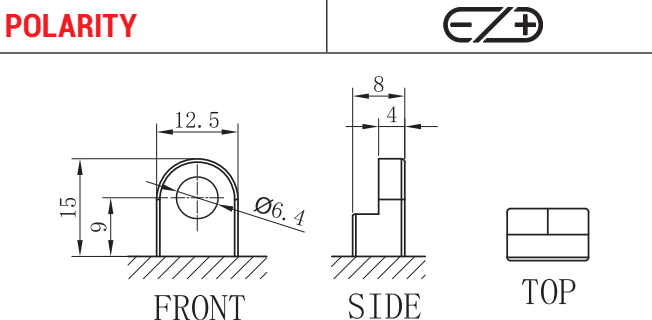

## MOUNTING ANGLE

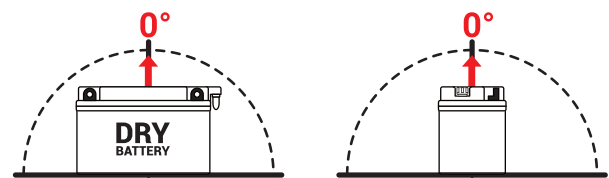

## UPGRADE FOR

SLA MAX	SLA	MF	DRY
-	-	-	-