

## 6N4B-2A-3

BS CODE: 310515

VOLTAGE **6V**

CCA -

CAPACITY 20HR **4.2Ah**

CAPACITY 10HR **4.0Ah**







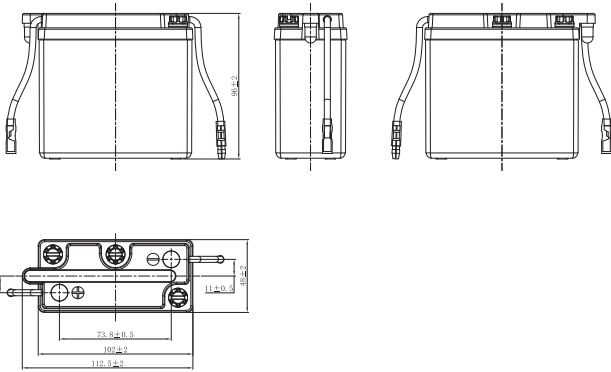

### DIMENSIONS

<b>LENGTH</b>	102 ±2mm	4.02 ±0.08inch
<b>WIDTH</b>	48 ±2mm	1.89 ±0.08inch
<b>TOTAL HEIGHT</b>	96 ±2mm	3.78 ±0.08inch
<b>WEIGHT</b>	0.62 kg ±5%	1.37 lbs ±5%



### DRY FEATURES

-  **TO BE ACTIVATED**  
DRY-charged technology.
-  **ACID PACK INCLUDED**  
For initial filling.
-  **PERIODIC MAINTENANCE**  
Refilled with water if necessary.
-  **HANDLE WITH CARE TO PREVENT ACID SPILLAGE**
-  **LONG SHELF LIFE**  
No need to be recharged while stocked (if not activated).
-  **INTERNAL GAS EMISSION THROUGH VENTING HOLE**
-  **WIDE VARIETY OF 6V & 12V MODELS**

### TERMINAL (mm)

**POLARITY** 

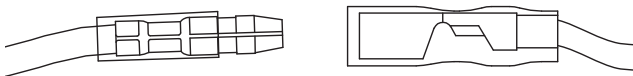

### MOUNTING ANGLE



### UPGRADE FOR

SLA MAX	SLA	MF	DRY
-	-	-	-