

## BTX20A-BS

BS CODE: **300808**

VOLTAGE **12V**

CCA **270A**

CAPACITY 20HR **18.9Ah**

CAPACITY 10HR **18.0Ah**



### DIMENSIONS



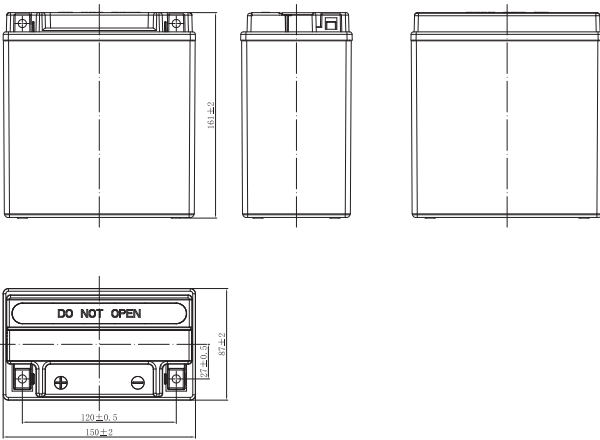

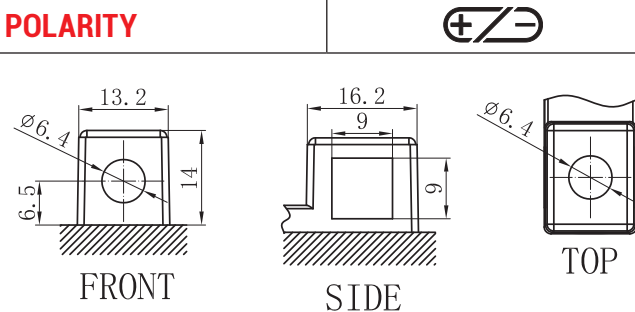

<b>LENGTH</b>	150 ±2mm	5.91 ±0.08inch
<b>WIDTH</b>	87 ±2mm	3.43 ±0.08inch
<b>TOTAL HEIGHT</b>	161 ±2mm	6.34 ±0.08inch
<b>WEIGHT</b>	4.1 kg ±5%	9.04 lbs ±5%



### TERMINAL (mm)



### MF FEATURES

-  **TO BE ACTIVATED**  
AGM (Absorbent Glass Mat) technology.
-  **ACID PACK INCLUDED**  
For initial filling.
-  **NO MAINTENANCE\***  
VRLA (Valve Regulated Lead Acid) design.
-  **TIGHTLY SEALED AFTER FILLING**  
Electrolyte is held in a glass fiber mat.
-  **SUPERIOR POWER & EXTENDED CYCLE LIFE**
-  **LONG SHELF LIFE**  
No need to be recharged while stocked (if not activated).

\*once activated

### MOUNTING ANGLE

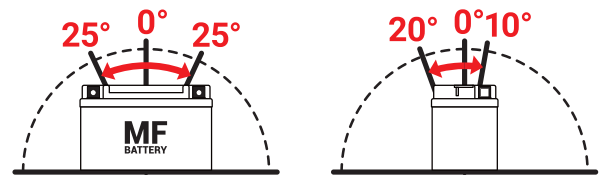

### UPGRADE FOR

SLA MAX	SLA	MF	DRY
-	-	-	-